

Lec

USER GUIDE

DF48B

CONTENTS

1 Safety warnings

1.1 Warning	1
1.2 Meaning of safety warning symbols	2
1.3 Electricity related warnings	2
1.4 Related warnings for use	3
1.5 Warnings related to placing items	4
1.6 Warnings for energy	4
1.7 Warnings related to disposal	4

2 Proper use of wine cooler

2.1 Names of components	5
2.2 Temperature Control	5
2.3 Move	6
2.4 Placement	6
2.5 Start to use	6
2.6 Energy saving tips	6

3 Maintenance of wine cooler

3.1 Disconnect the wine cooler	7
3.2 Stop using the wine cooler	7
3.3 Clean the wine cooler	7
4 Trouble shooting	8

DEAR CUSTOMER:

Thank you for buying this wine cooler. To ensure that you get the best results from your new wine cooler, please take time to read through the simple instructions in this booklet. Please ensure that the packing material is disposed of in accordance with the current environmental requirements. When disposing of any wine cooler equipment, please contact your local waste disposal department for advice on safe disposal. This appliance must only be used for its intended purpose.

1 Safety warnings

1.1 Warning



Warning: risk of fire/ flammable materials

RECOMMENDATIONS:

This appliance is intended to be used in household and similar environments only.

(Europe directive optional)

For EN standard: This appliance can be used by children aged from 8 years and above and persons with reduce physical sensory or mental capabilities or lack of experience and knowledge if they have been given supervision or instruction concerning use of the appliance in a safe way and understand the hazards involved. Children should not play with the appliance. Cleaning and user maintenance shall not be made by children without supervision.

(Europe directive optional)

For IEC standard: This appliance is not intended for use by persons (including children) with reduced physical, sensory or mental capabilities, or lack of experience and knowledge, unless they have been given supervision or instruction concerning use of the appliance by a person responsible for their safety.)

Children should be supervised to ensure that they do not play with the appliance.

If the supply cord is damaged, it must be replaced by the manufacturer, its service agent or similarly qualified persons in order to avoid a hazard.

Do not store explosive substances such as aerosol cans with a flammable propellant in this appliance.

The appliance has to be unplugged after use and before carrying out user maintenance on the appliance.

WARNING: Risk of fire/ flammable materials.

WARNING: Keep ventilation openings, in the appliance enclosure or in the built-in structure, clear of obstruction.

WARNING: Do not use mechanical devices or other means to accelerate the defrosting process, other than those recommended by the manufacturer.

WARNING: Do not damage the refrigerant circuit.

WARNING: Do not use electrical appliances inside the food storage compartments of the appliance, unless they are of the type recommended by the manufacturer.

WARNING: Please dispose of the refrigerator according to local regulations as it uses flammable blowing gas and refrigerant.

Do not use extension cords or ungrounded (two prong) adapters

DANGER: Risk of child entrapment. Before you throw away your old refrigerator or freezer:

-Take off the doors



-Leave the shelves in place so that children may not easily climb inside

The refrigerator must be disconnected from the source of electrical supply before attempting the installation of accessory

Refrigerant and cyclopentane foaming material used for the refrigerator are flammable.

Therefore, when the refrigerator is scrapped, it should be kept away from any fire source and be recovered by a special recovering company with corresponding qualifications you should not dispose of the appliance by setting fire to it.

1.2 Meaning of safety warning symbols

	The symbols indicate prohibited behaviours, non-compliance with the instructions may result in product damages or endanger the personal safety of users.
	The symbols indicate behaviours that must be followed, and those behaviors must be strictly followed in line with the operation requirements. Non-compliance with the instructions may result in product damages or endanger the personal safety of users.
	The symbols indicate matters to pay attention to, and these behaviors shall be specially noted. Due precautions are needed or minor or moderate injuries or damages of the product will be caused.

(This manual contains lots of important safety information which shall be observed by the users.)

1.3 Electricity related warnings

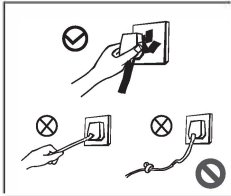

- Do not pull the power cord when pulling the power plug of the wine cooler. Please firmly grasp the plug and pull it out from the socket directly.
- Do not damage the power cord, do not use when the power cord is damaged or the plug is worn.
- A worn or damaged power cord needs to be replaced by an authorised service agent.

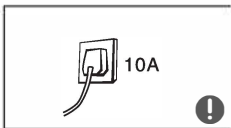

- Please use a dedicated three-hole power socket which is 10A or more and the power socket should not be shared with other electrical appliances.
- The power cord should be firmly contacted with the socket to reduce the risk of fire. Please ensure that the grounding electrode of the power socket is equipped with a reliable grounding line.



- The machine uses AC power supply of 220-240V/50 Hz. If the voltage fluctuation exceed the range of $220V \pm 10\%$, it can cause faults or even damage of wine cooler.
- In cases of gas leaks, turn off at the mains, then open the doors and windows in the room / buildings. Do not unplug the cooler or other electrical appliances as a spark could cause a fire.

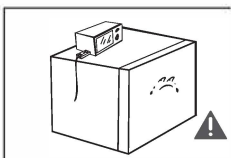

- Do not place any other electrical appliances on top of the wine cooler.

1.4 Warnings related to use

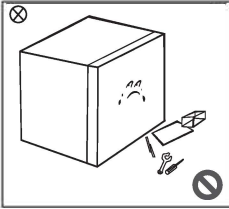

- Do not disassemble or reconstruct the wine cooler, nor damage the refrigerant circuit; maintenance of the appliance must be conducted by an authorised service agent.
- A damaged power cord must be replaced by the manufacturer, or an authorised service agent.

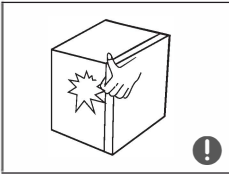

- The gaps between cooler door and cooler body are small, please do not put your hand in the gaps, as it could lead to your finger getting trapped. When opening the door please be aware of contents falling.

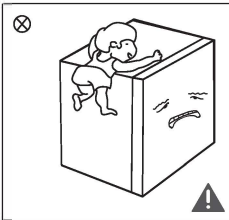

- Do not give packaging components to children to play with. The bending board and plastic film could lead to suffocation! Do not allow children to climb into or on the cooler as there is a threat of suffocation or a risk of injury through falling.
- Do not spray or wash the cooler. Locate the cooler away from moisture or away from direct water contact, due to the threat of electrocution.
- Do not use cooler body, cooler door, or any part of the cooler as a step.

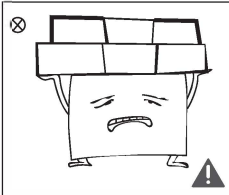

- Do not place heavy objects on the top of the cooler as they may fall when the door is opened or closed.
- Please pull out of the plug in case of power failure or cleaning. Do not connect the cooler to power supply within five minutes to prevent damages to the compressor due to successive starts.

1.5 Warnings related to placing items

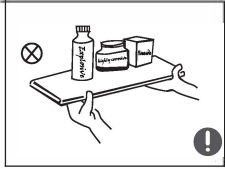

- Do not put flammable, explosive, volatile and highly corrosive items in or near the cooler as they pose a fire risk.

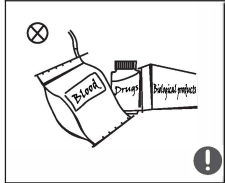

- This product is a household cooler and this equipment should only be used for the storage of drinks. According to the standard requirements the cooler should not be used for other purpose, such as the storage of blood, drugs or biological products.

1.6 Warnings for energy

1) The wine cooler might not operate consistently if sited for an extended period of time below the minimum specified operating temperature.

2) All drinks stored in the cooler should not exceed the manufacturers "use by" date.

1.7 Warnings related to disposal



Refrigerant and cyclopentane foaming material used for the wine cooler are flammable. Therefore when the wine cooler is scrapped it should be kept away from fire and should be recovered by a specialist company or local authority.



When the wine cooler is scrapped, disassemble the doors and remove the gaskets from the door and shelves, to ensure that children cannot be trapped in the appliance.



Correct Disposal of this product:

This marking indicates that this product should not be disposed with other household wastes throughout the EU. To prevent possible harm to the environment or human health from uncontrolled waste disposal, recycle it responsibly to promote the sustainable reuse of material resources. To return your used device, please use the return and collection systems or contact the retailer where the product was purchased. They can take this product for environmental safe recycling.

2.0 Proper use of wine cooler

2.1 Names of components

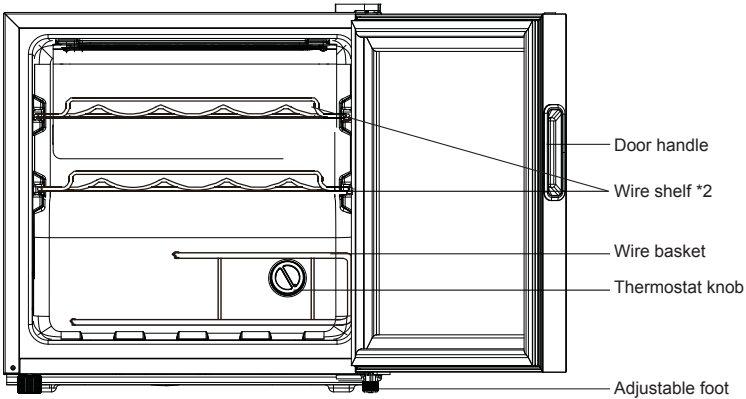

Some of the accessories may not be entirely consistent with the image above

2.2 Temperature Control

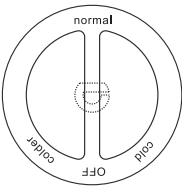

After the wine cooler has been turned on, turn the temperature control knob to adjust the level of temperature. Setting the control to cold is the warmest setting, and the temperature can be reached from 15 °C to 21 °C; Setting the control to colder is the coldest setting, and the temperature can be reached from 3 °C to 9 °C; Setting the control to normal is normal setting, the temperature can be reached from 9 °C to 15 °C. Moving the control to OFF stops cooling.

2.3 Moving the appliance

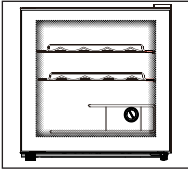

- There are two wheels at the rear of the cooler these can be used to move the cooler, the cooler should not be moved over uneven ground.

2.4 Placement

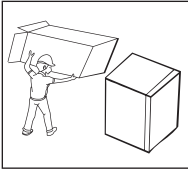

- Before using the cooler, remove all packaging materials including bottom cushions and foam pads and tape inside the cooler, tear off the protective film on the door and the cooler body.

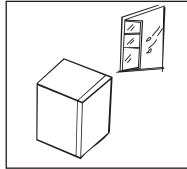

- The cooler should be placed in a well ventilated indoor place. The ground should be flat and sturdy rotate the adjustable legs until stable.

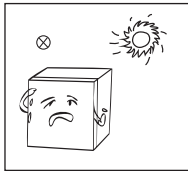

- Avoid direct sunlight and heat sources such as cookers and radiators etc. If the cooler has to be placed next to a heat source a suitable insulation board should be applied or keep away from the heat source

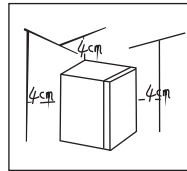

- Hot air from the cooler need to be dispersed, otherwise the appliance's efficiency could be reduced. Thus the distance between the cooler, walls or from the neighbouring furniture shouldnot be less than 4cm. It is also necessary to allow for the doors to open at least 90°

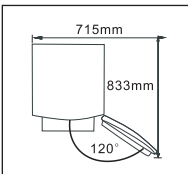

- Please leave enough space to ensure feasible opening.
- Dimensions shown are for reference only

2.5 Start to use

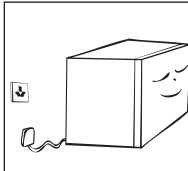

- Before the wine cooler is turned on for the first time the appliance should sit for half an hour, before it is connected to 220~240V/50Hz power.
- The wine cooler should be turned on for 2 to 3 hours before loading drinks; in the summer this time should be increased to 4 hours.

2.6 Energy Conservation

- The wine cooler should be placed in a dry well ventilated room. The wine cooler should not be put in direct sunlight or next to a heat source (such as radiators or cookers etc) without a suitable insulation board being used.
- Try to minimize the number of times and length of time the door is opened.
- Only put food / drinks into the cooler after it has cooled down.

3 Proper use of wine cooler

3.1 Disconnect the wine cooler

Unplug power plug to disconnect the wine cooler.

3.2 Stop using the wine cooler

If the wine cooler is left unused for a long time, please:

1. Unplug the wine cooler;
2. Clean the wine cooler;
3. Keep the wine cooler door open.

3.3 Cleaning the wine cooler

Removing dust behind and underneath the wine cooler will improve the appliance performance. The interior of the wine cooler should be cleaned regularly to avoid odour. To do this please follow these steps:

1. Unplug power plug,
2. Clean door seal with only clear water and give thorough wipe,
3. Use slightly warm water and a little dish soap to clean wine cooler. Do not let water spill onto operation control elements and illuminator on glazed door,
4. Turn power back on when cleaning is completed.



- Do not use hard brushes, steel balls, wire brushes, abrasives, such as toothpastes, organic solvents (such as alcohol, acetone, etc.), boiling water, acid or alkaline items as they may damage the wine cooler surface and interior.
- Do not rinse with water as this may affect the electrical insulation properties.
- Do not use detergent and solvent with sand or acid. The drain hole should be cleaned regularly to ensure water can be drained. Clean the drain hole with a thin stick or something similar.

4 Trouble shooting

<p>Inoperation</p>	<p>If the cooler is unplugged and unconnected to power; Low voltage; Thermostat knob is set to off. Failure power or tripping circuit</p>
<p>Odor</p>	<p>Odorous foods should closely wrapped; Food is rotten; Interior needs cleaning</p>
<p>Long-term operation of compressor</p>	<p>It is normal that cooler operates for longer time in summer when the ambient temperature is higher; Do not load too many drinks into the cooler in one go; The frequent opening of cooler door.</p>
<p>Illuminating light does not shine</p>	<p>Cooler not connected to power; Indicator light is damaged</p>
<p>Loud noises</p>	<p>Food / Drinks are not level; Cooler is unbalanced; Interior furniture is not properly placed</p>
<p>Transient difficulty in door opening</p>	<p>After refrigeration, there will be pressure difference between the inside and the outside of the cooler this could lead to a difficulty in opening the door. This is normal.</p>
<p>cooler enclosure heat Condensation</p>	<p>The cooler enclosure may emit heat during operation specially in summer, this is caused by the radiation of the condenser and is normal. Condensation: condensation may form on the exterior surface and door seals when the ambient humidity is high. This is normal and can be wiped away with a dry cloth.</p>
<p>Airflow sound Buzz Clatter</p>	<p>Refrigerants circulating in the refrigerant lines will produce an eruption of sound and grunts which is normal, it does not affect the cooling effect. A buzz can be generated by the compressor specially when starting up or shutting down. The solenoid valve or electric switch will clatter which is normal and does not affect operation.</p>

Product fiche concerning the "COMMISSION DELEGATED REGULATION (EU) No 1060/2010"

Trade mark: LEC
Moder Identifier: DF48B
Category of the household refrigerating appliance model: wine cooler
Energy efficiency class: A+
Energy consumption 105 kWh/annum, based on standard test results for 24 hours. Actual energy consumption will depend on how the appliance is used and where it is located.
Storage volume cooling compartment (l) 43
Storage volume freezing compartment (l) /
Frost free: /
Temperature rise time: /
Freezing capacity: /
Climate class: N . This appliance is intended to be used at an ambient temperature between 16°C and 32°C.
Airborne acoustical noise emissions: 42 dB(A) re 1pW
Free-standing

Lec Guarantee

Your Lec wine cooler is made from the very best materials to the highest standards of manufacture and has been extensively tested and inspected before leaving our factory. It conforms with current British and European Electrical Safety Standards. It is guaranteed for one year from the date of purchase, against mechanical and material defects, with the exception of light bulbs.

In the event of a defect to which this guarantee applies, please produce your receipt (as proof of purchase) to your supplier, who will make the necessary arrangements for rectification as quickly as possible.

This guarantee does not apply if:

- The wine cooler has been improperly installed or used in a manner contrary to the operating instructions issued with it.
- The wine cooler has been treated in an abnormal or abusive manner
- The wine cooler has been used for industrial or commercial purposes.
- Any repair work has been carried out by any person other than a Lec approved engineer.
- Any parts have been fitted which are not genuine Lec approved parts.
- The wine cooler has been modified in any way or the serial number has been removed or altered.
- Any toxic or corrosive products have been used or stored in or near to the wine cooler.

Without prejudice to the rights of the buyer no liability is accepted for any consequential loss or damage resulting from failure of the wine cooler or for any reason whatsoever. You are strongly advised to insure under the special Lec Protection Plan which is enclosed with this guarantee or which is obtainable from the company.

Acceptance of this guarantee does not affect your statutory rights: Consumer Transactions (Restrictions on Statements) Order 1976.

This guarantee is applicable only in the United Kingdom and Channel Islands.

Lec

Lec Refrigeration

Stoney Lane, Prescot, Merseyside, L35 2XW

0344 815 3737

www.lec.co.uk

Lec Refrigeration, a division of Glen Dimplex Home Appliances